

VR 28 SÜRME ve SİSTEM PROFİLLER

VR 28 SLIDING AND
SYSTEM PROFILES



VR
VIALO ROKSA
VR

MİMARİ SİSTEMLER

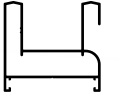

VR 28 SÜRME VE SİSTEM PROFİLLERİ
VR 28 SLIDING AND SYSTEM PROFILES

VR
VIALO ROKSA

MİMARİ SİSTEMLER

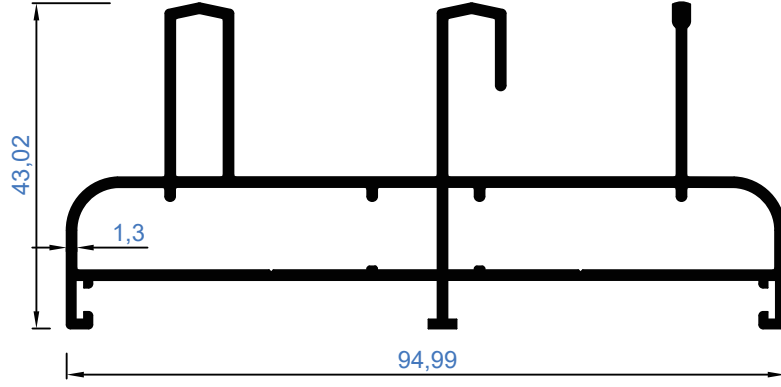

VR 4001 | Ağırlık - Weight
1,301 Kg/Mt

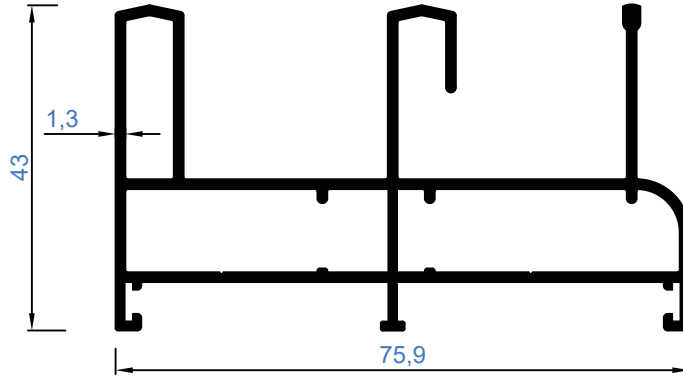

VR 4002 | Ağırlık - Weight
1,160 Kg/Mt

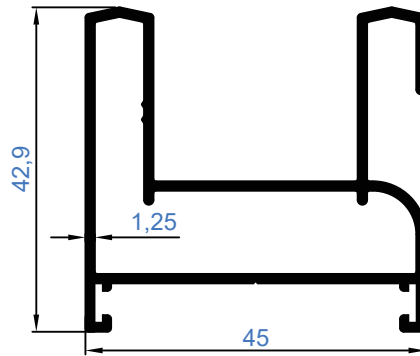

VR 4003 | Ağırlık - Weight
0,733 Kg/Mt

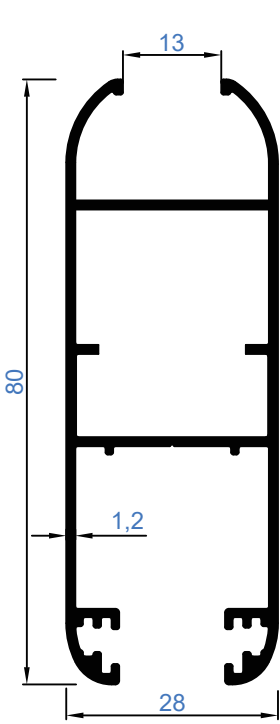
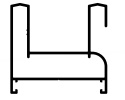

VR 4004 | Ağırlık - Weight
0,850 Kg/Mt

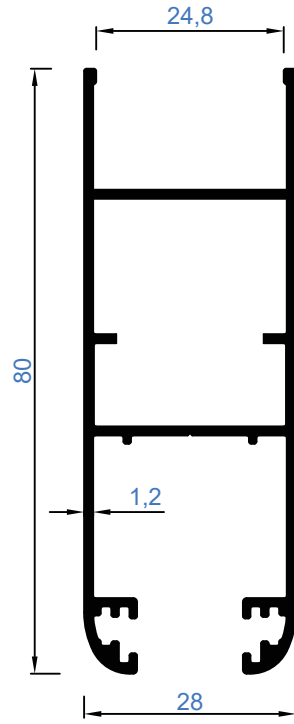

VR 4005 | Ağırlık - Weight
0,833 Kg/Mt

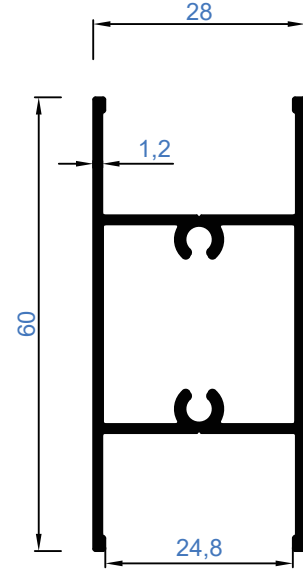

VR 4006 | Ağırlık - Weight
0,655 Kg/Mt

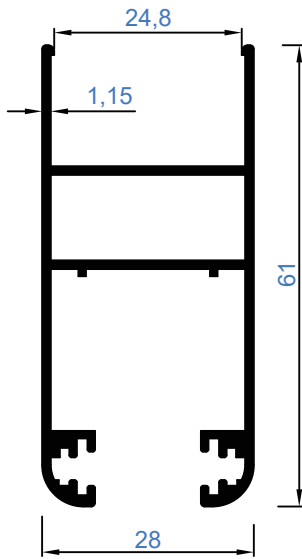

VR 4007 | Ağırlık - Weight
0,679 Kg/Mt

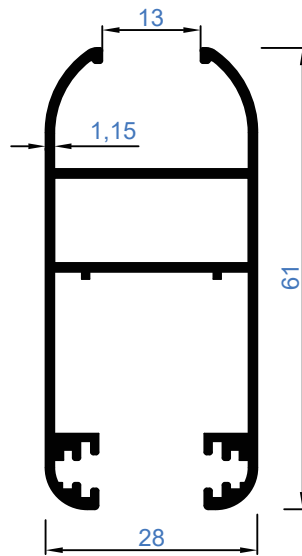

VR 4008 | Ağırlık - Weight
0,700 Kg/Mt

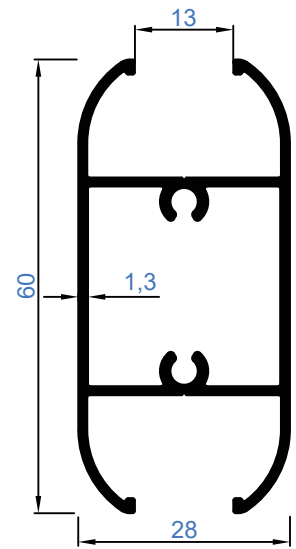

VR 4009 | Ağırlık - Weight
0,690 Kg/Mt

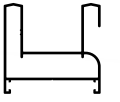

VR 28 SÜRME VE SİSTEM PROFİLLERİ
VR 28 SLIDING AND SYSTEM PROFILES

VR
VIALO ROKSA

MİMARİ SİSTEMLER

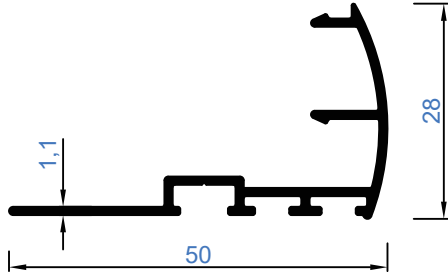

VR 4010 | Ağırılık - Weight
0,329 Kg/Mt

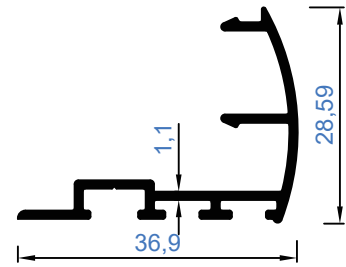

VR 4011 | Ağırılık - Weight
0,289 Kg/Mt

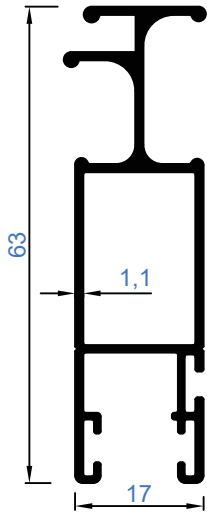

VR 4012 | Ağırılık - Weight
0,561 Kg/Mt

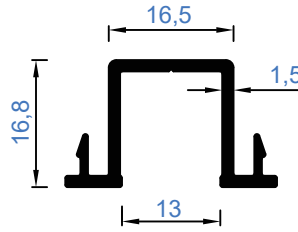

VR 4013 | Ağırılık - Weight
0,270 Kg/Mt

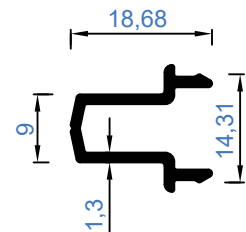

VR 4014 | Ağırılık - Weight
0,176 Kg/Mt

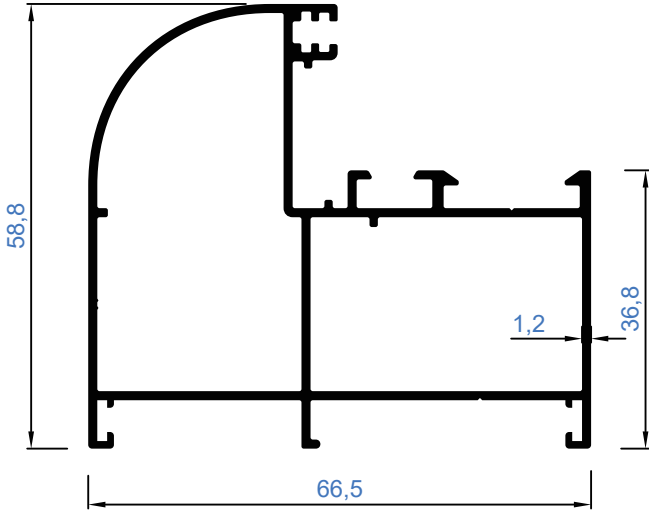
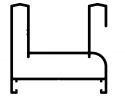

VR 4015 | Ağırılık - Weight
1,043 Kg/Mt

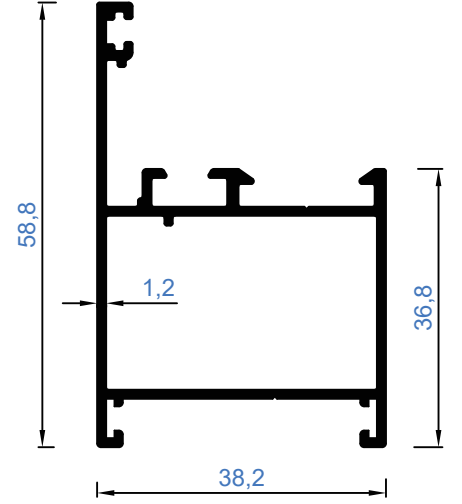

VR 4016 | Ağırılık - Weight
0,680 Kg/Mt

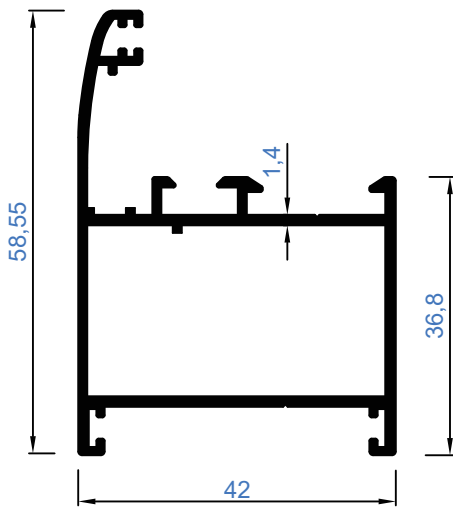

VR 4017 | Ağırılık - Weight
0,788 Kg/Mt

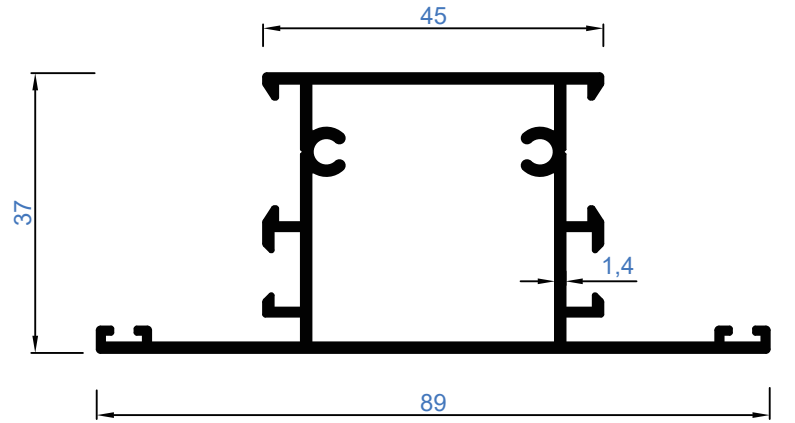

VR 4018 | Ağırılık - Weight
1,004 Kg/Mt

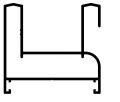

VR 28 SÜRME VE SİSTEM PROFİLLERİ

VR 28 SLIDING AND SYSTEM PROFILES

VR
VIALO ROKSA

MİMARİ SİSTEMLER

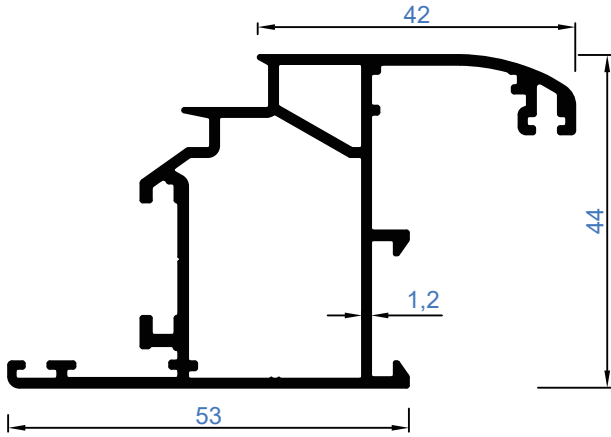

VR 4019 | Ağırlık - Weight
0,891 Kg/Mt

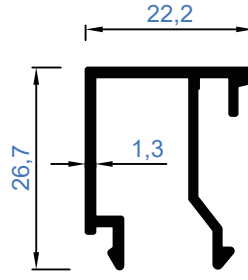

VR 4020 | Ağırlık - Weight
0,292 Kg/Mt

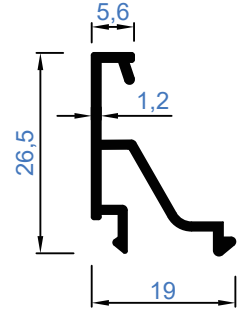

VR 4021 | Ağırlık - Weight
0,204 Kg/Mt

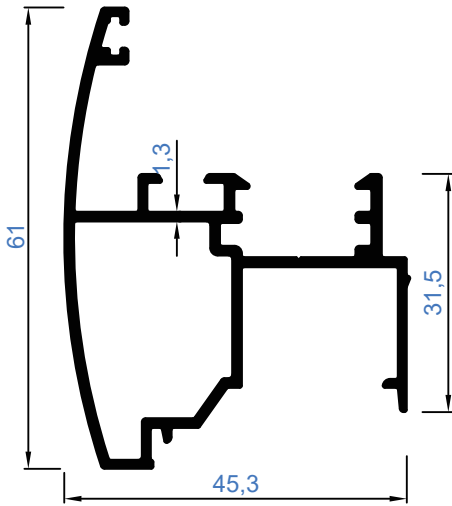

VR 4022 | Ağırlık - Weight
0,776 Kg/Mt

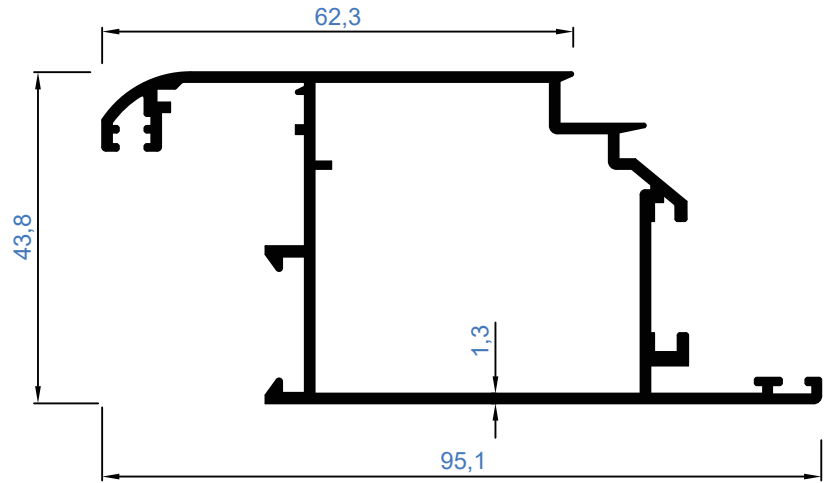

VR 4023 | Ağırlık - Weight
1,020 Kg/Mt

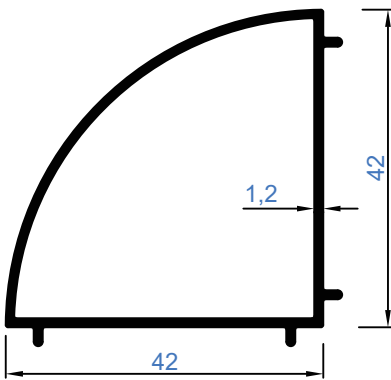

VR 4024 | Ağırlık - Weight
0,487 Kg/Mt

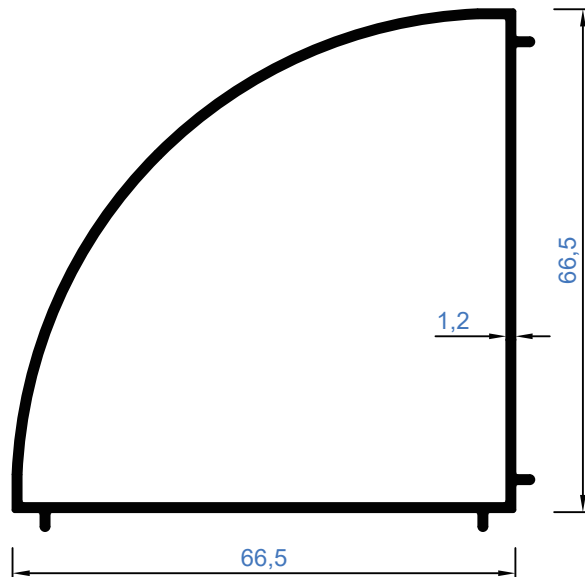

VR 4025 | Ağırlık - Weight
0,792 Kg/Mt

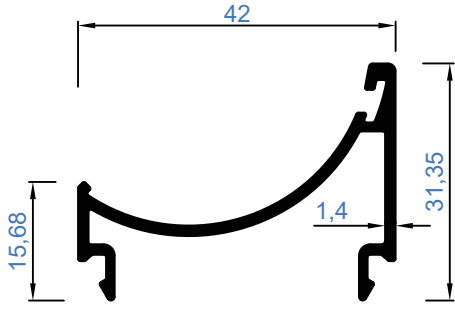
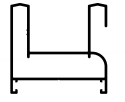

VR 4026 | Ağrlık - Weight
0,405 Kg/Mt

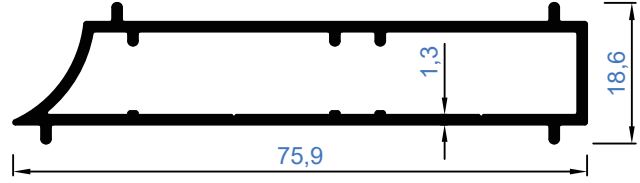

VR 4027 | Ağrlık - Weight
0,644 Kg/Mt

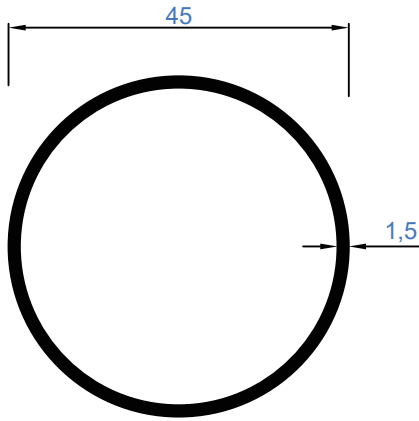

VR 4028 | Ağrlık - Weight
0,556 Kg/Mt

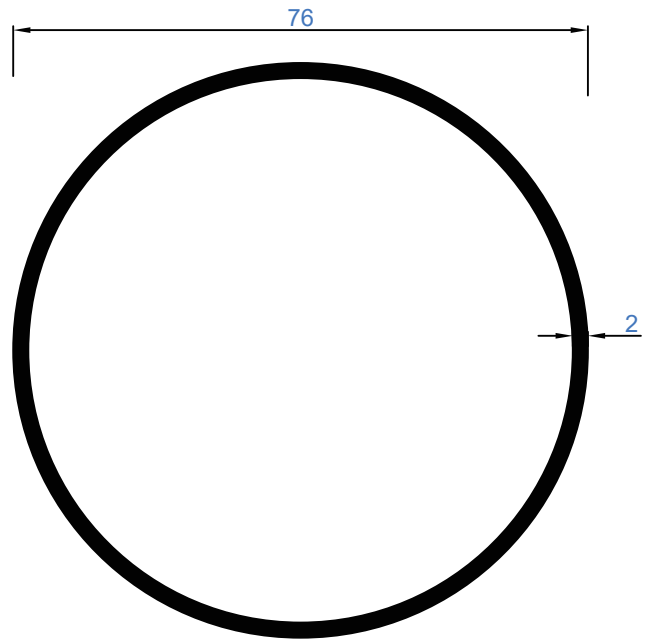

VR 4029 | Ağrlık - Weight
1,260 Kg/Mt

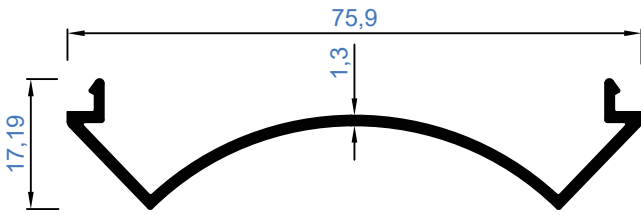

VR 4030 | Ağrlık - Weight
0,379 Kg/Mt

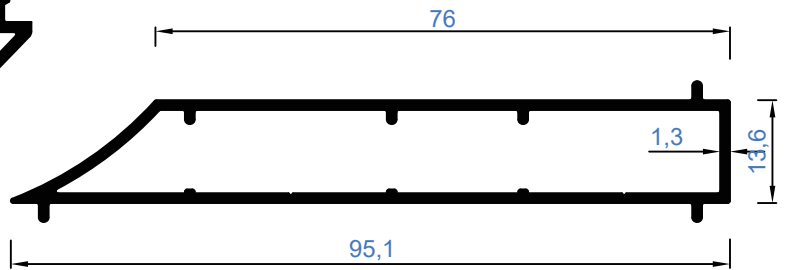

VR 4031 | Ağrlık - Weight
0,757 Kg/Mt

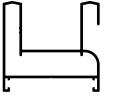

VR 28 SÜRME VE SİSTEM PROFİLLERİ
VR 28 SLIDING AND SYSTEM PROFILES

VR
VIALO ROKSA

MİMARİ SİSTEMLER

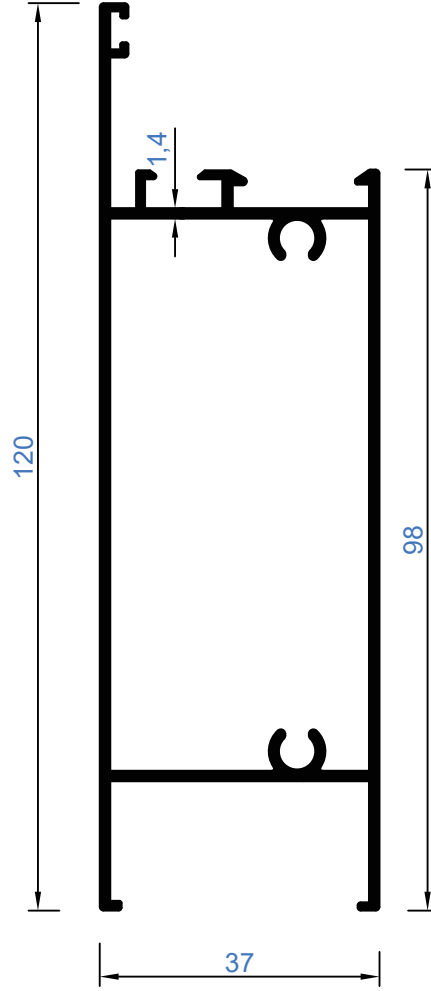



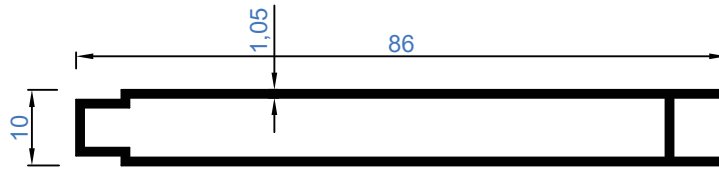



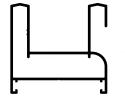

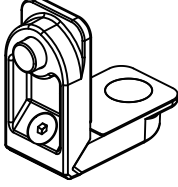
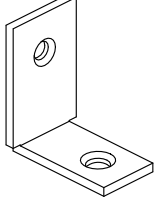
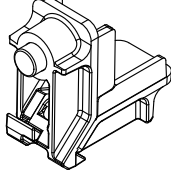
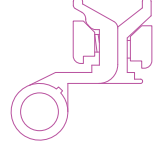

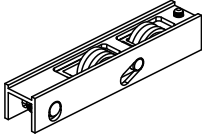
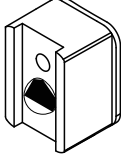
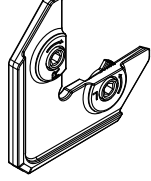
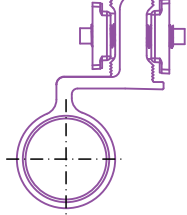
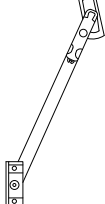
VR 4033 | Ağırlık - Weight
1,268 Kg/Mt

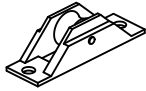
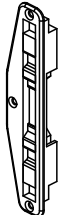
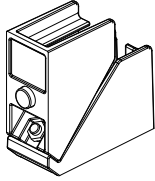
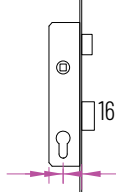
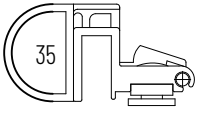

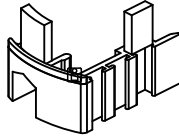
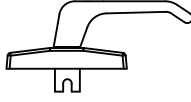
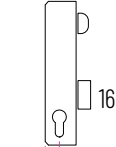
VR 4032 | Ağırlık - Weight
0,534 Kg/Mt

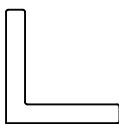
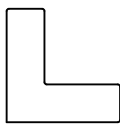
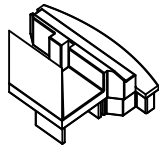
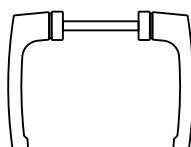

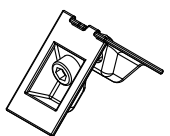
 <p>IMZ 10 EPDM FİTİL EPDM GASKET</p>	 <p>LC-1125 ALYAN KÖŞE CORNER JOINT</p>	 <p>IMZ 27 ORTAKAYIT BAĞLANTI MIDDLE JOINT</p>	 <p>LC-2327 ALYAN KÖŞE CORNER JOINT</p>	 <p>IMZ 35 SİSTEM MENTEŞE SYSTEM HINGE</p>	 <p>IMZ 38 MAKARALI KİLİT KARŞILIĞI ROLLER LOCK STRIKES</p>
 <p>IMZ 11 EPDM FİTİL EPDM GASKET</p>	 <p>IMZ 24 RULMAN - ROLLER</p>	 <p>IMZ 28 STOPER STOPPER</p>	 <p>IMZ 32 ALYAN KÖŞE CORNER JOINT</p>	 <p>IMZ 36 SİSTEM KAPI MENTEŞESİ SYSTEM DOOR HINGE</p>	 <p>IMZ 39 VASİSTAS MAKASI TRANSOM RESTRICTER</p>
 <p>IMZ 12 EPDM FİTİL EPDM GASKET</p>	 <p>IMZ 25 RULMAN - SİNEKLİK ROLLER - FYLSCREEN</p>	 <p>IMZ 29 HAVUZ KOL POOL HANDLE</p>	 <p>LC-4327 ALYAN KÖŞE CORNER JOINT</p>	 <p>153-35-D DİLLİ KİLİT MOURTISE LOCK WITH CYLINDER</p>	 <p>IMZ 40 VASİSTAS MANDAL VASİSTAS SPRING</p>
 <p>IMZ 13 EPDM FİTİL EPDM GASKET</p>	 <p>IMZ 26 SIZDIRMAZLIK PARÇASI TIGHTNESS PART</p>	 <p>IMZ 30 KENET KAPAKGI CLAMP COVER</p>	 <p>IMZ 33 EKSENEL KOL AXIAL HANDLE</p>	 <p>153-35-M MAKARALI KİLİT MOURTISE LOCK WITH ROLLER</p>	 <p>IMZ 41 KAPI ALTI FIRÇA BRUSH GASKET</p>
					 <p>KİL-67 / 600 KİL FİRİL BRUS GASKET</p>
 <p>IMZ 22 KÖŞE GÖNYESİ CORNER ALIGNMENT</p>	 <p>IMZ 23 KÖŞE GÖNYESİ CORNER ALIGNMENT</p>	 <p>IMZ 31 ADAPTÖR KAPAKGI ADAPTER COVER</p>	 <p>IMZ 34 KAPI KOLU DOOR HANDLE</p>	 <p>IMZ 37 DİLLİ KİLİT KARŞILIĞI LOCK STRIKES</p>	 <p>IMZ 42 ALYAN KÖŞE CORNER JOINT</p>

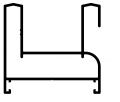

VR 28 SÜRME VE SİSTEM PROFİLLERİ
VR 28 SLIDING AND SYSTEM PROFILES

VR
VIALO ROKSA

MİMARİ SİSTEMLER

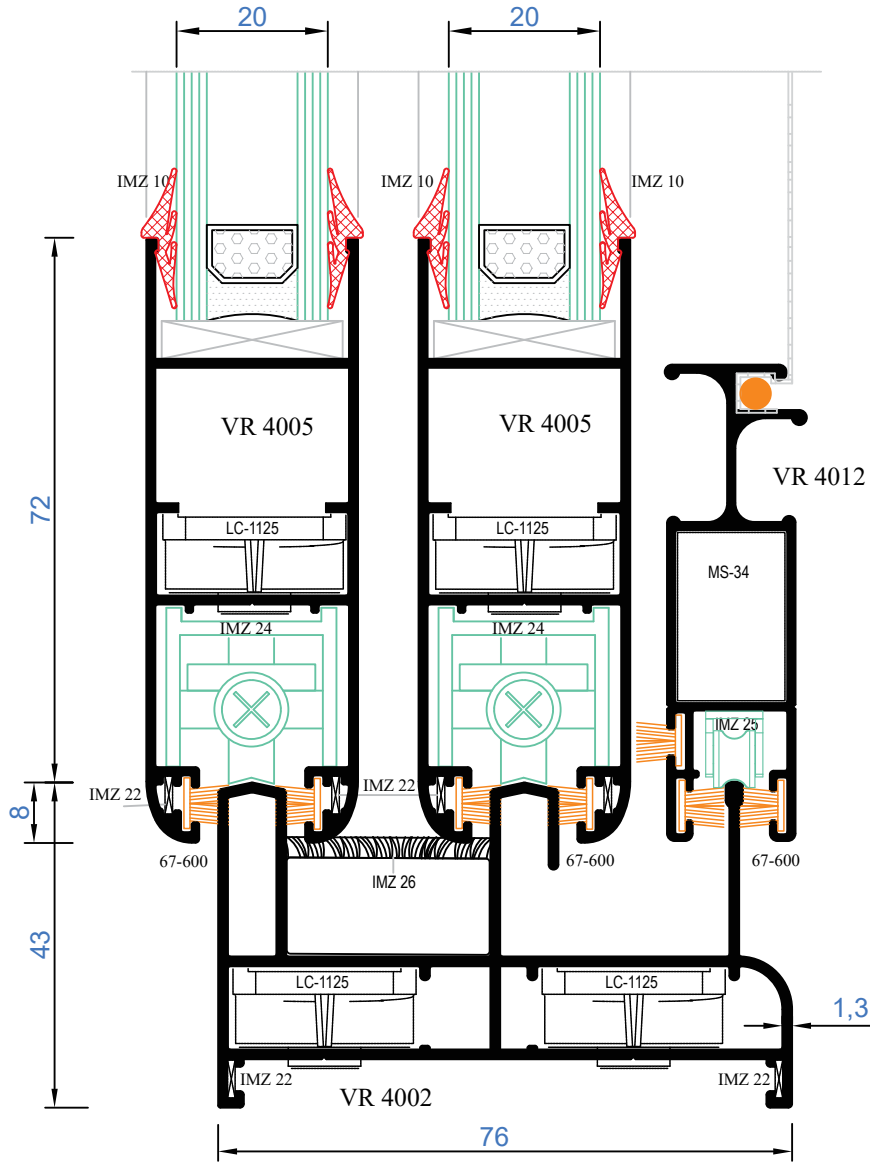

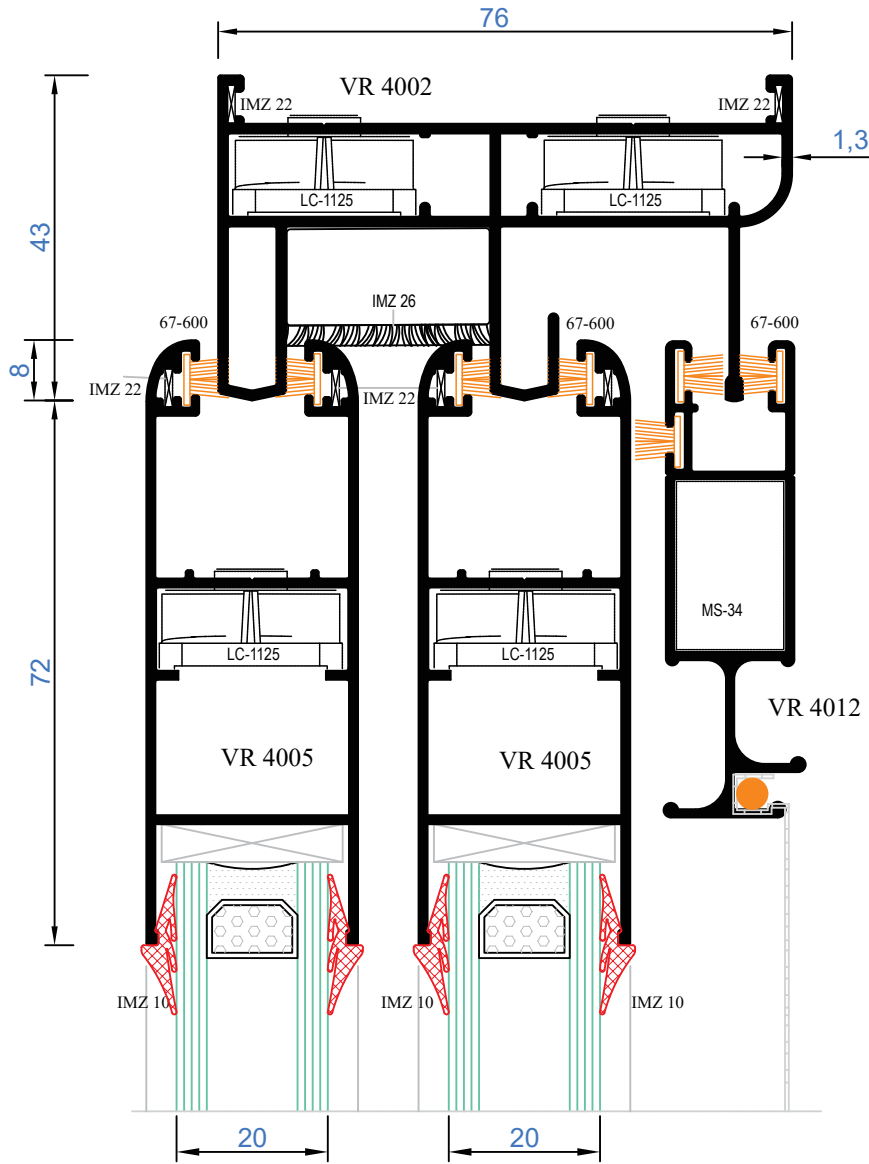
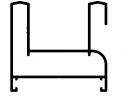

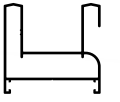

VR 28 SÜRME VE SİSTEM PROFİLLERİ
VR 28 SLIDING AND SYSTEM PROFILES

VR
VIALO ROKSA

MİMARİ SİSTEMLER

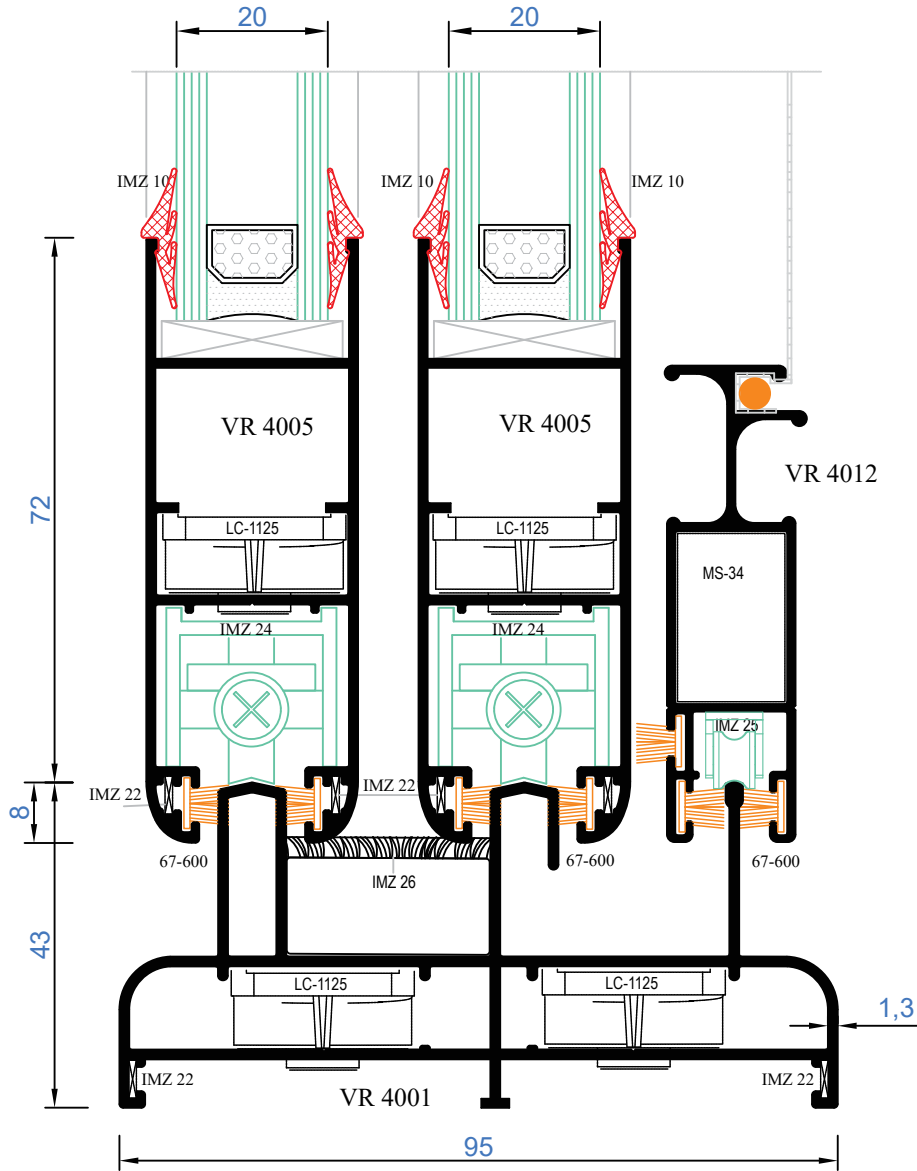

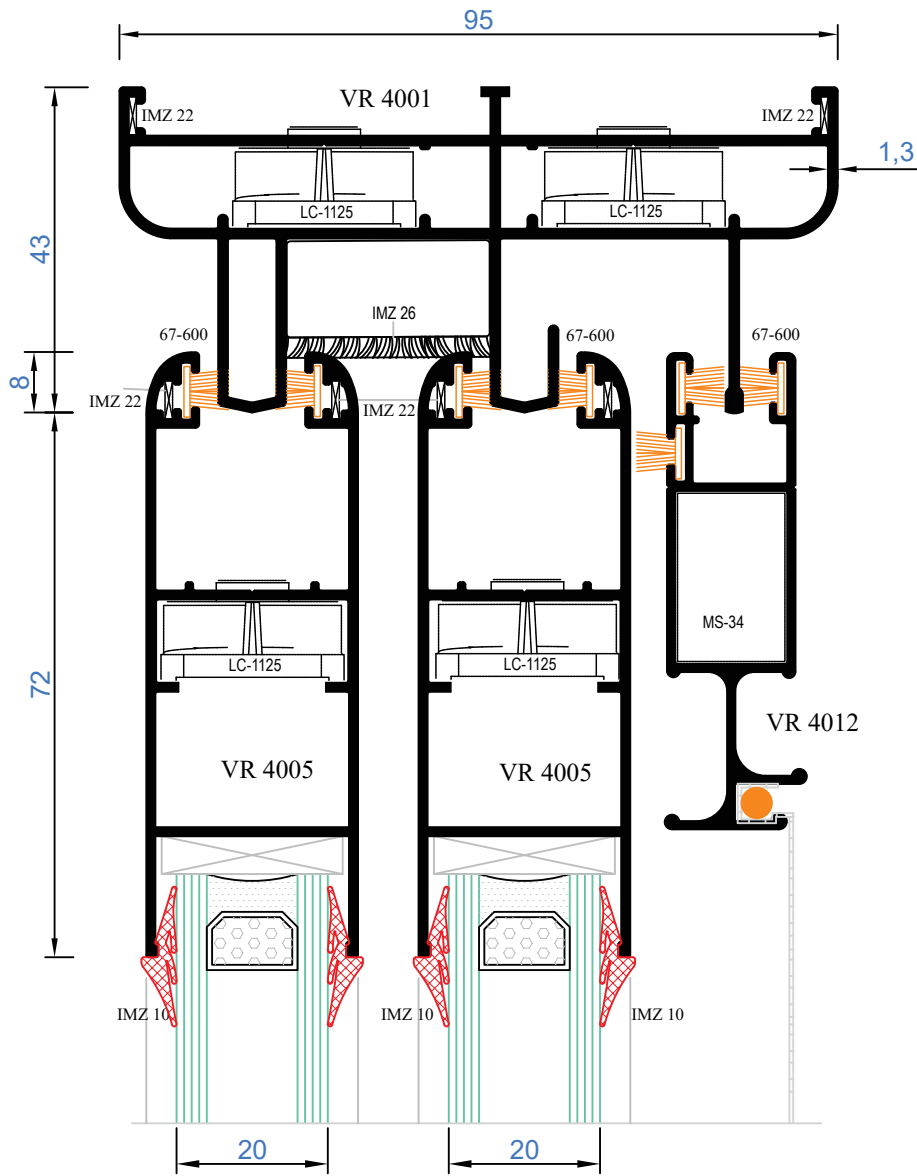
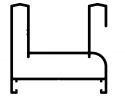

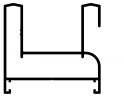

VR 28 SÜRME VE SİSTEM PROFİLLERİ

VR 28 SLIDING AND SYSTEM PROFILES

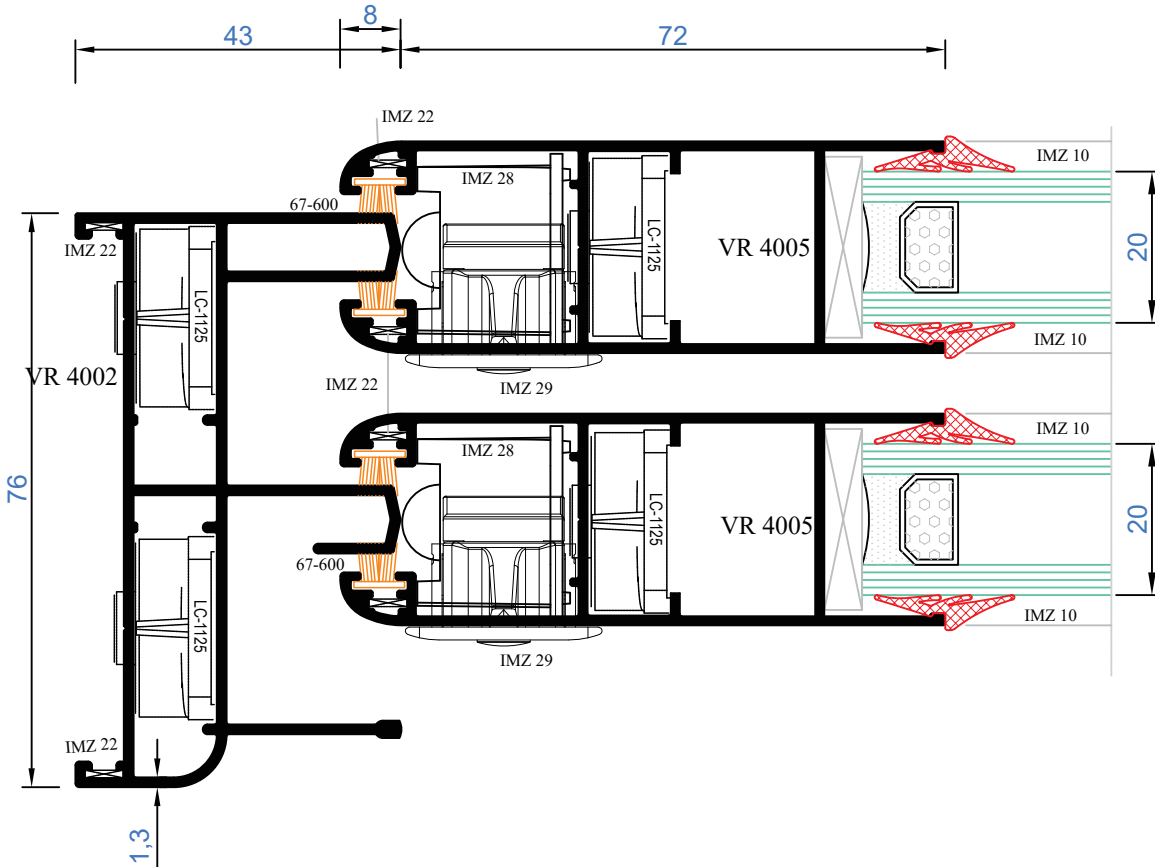
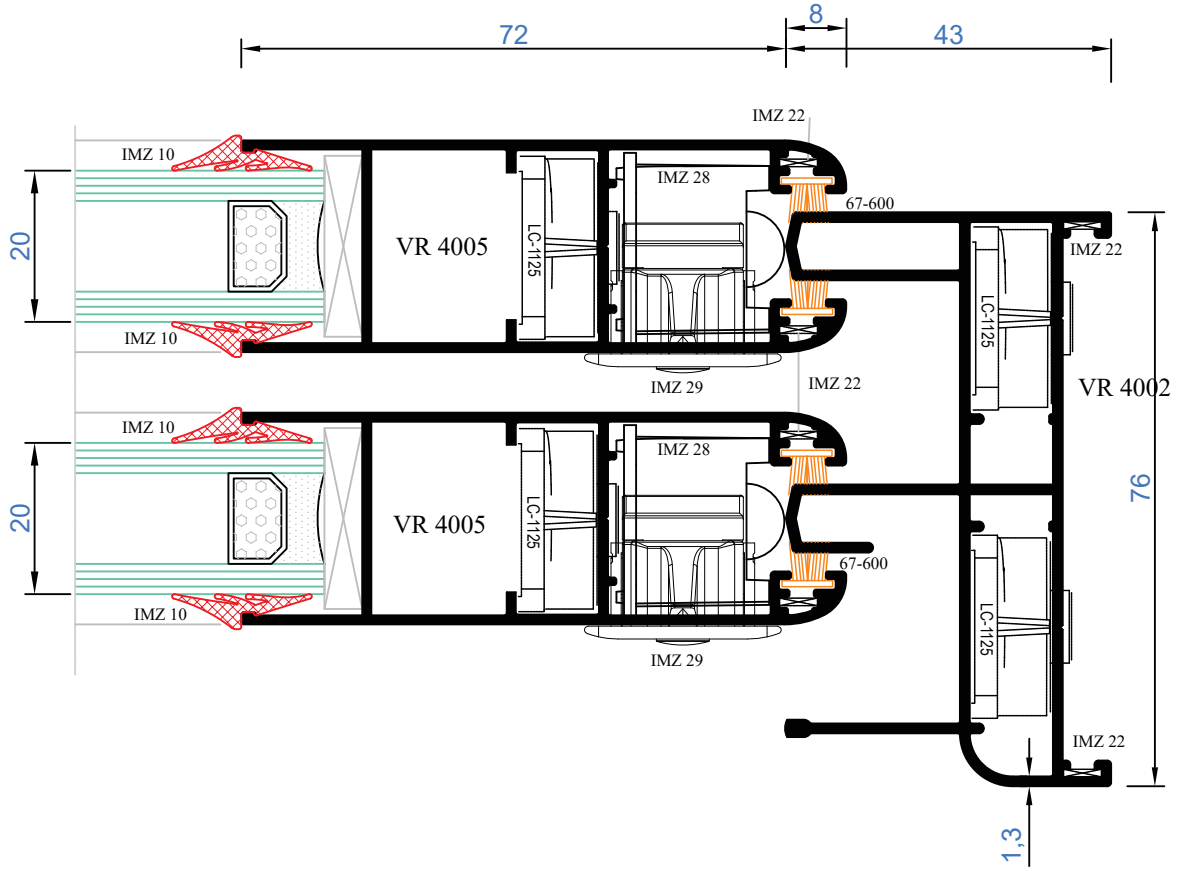

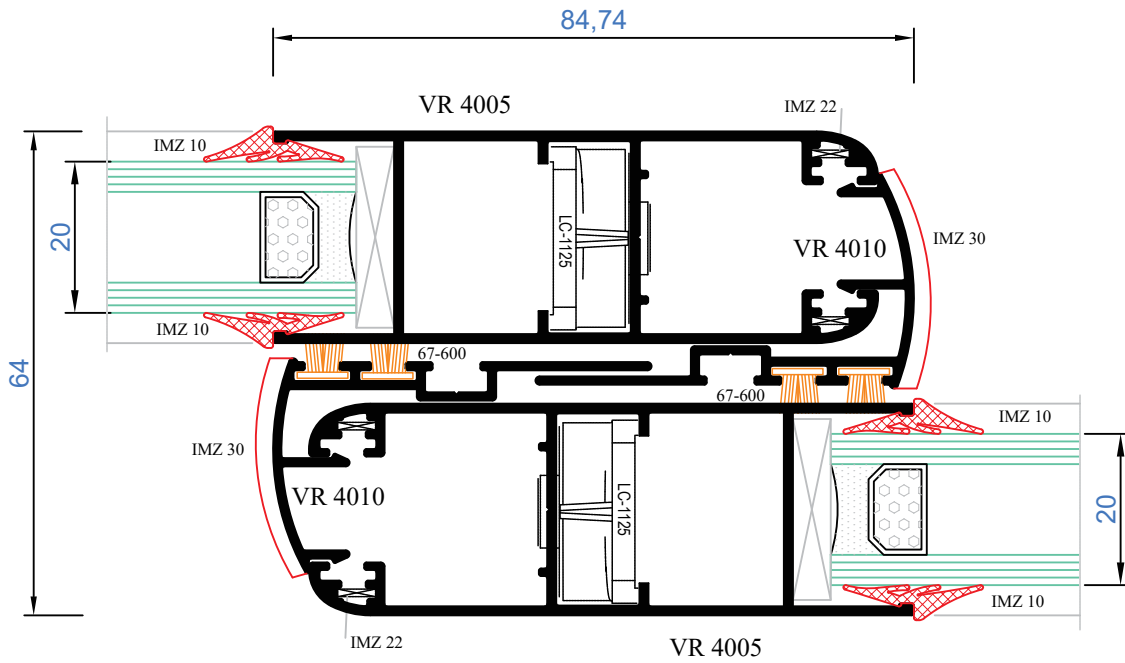
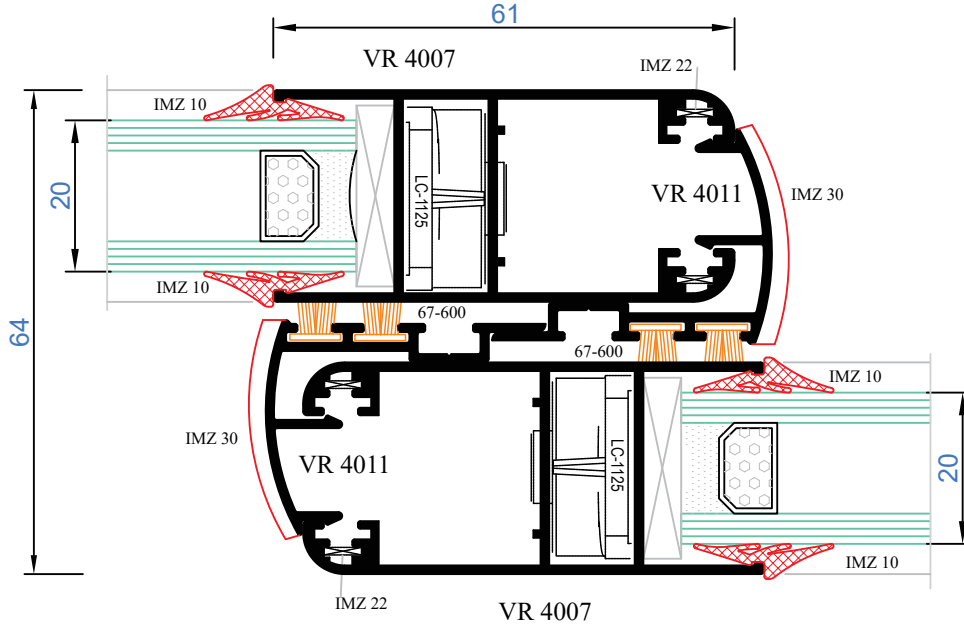
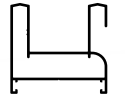

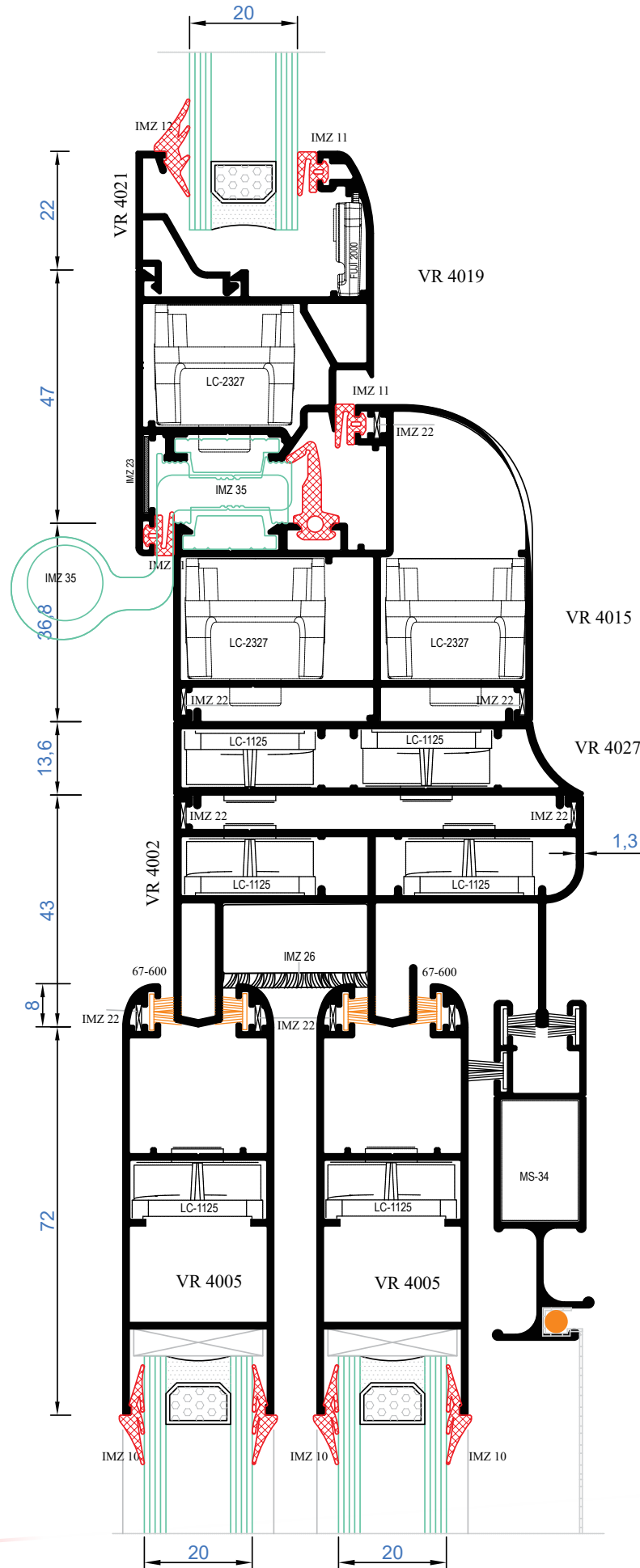
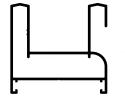

NOT: Profil ağırlıkları teoriktir, üretim sonrası ağırlıklar geçerlidir.

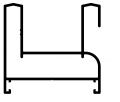

VR 28 SÜRME VE SİSTEM PROFİLLERİ

VR 28 SLIDING AND SYSTEM PROFILES

VR
VIALO ROKSA

MİMARİ SİSTEMLER

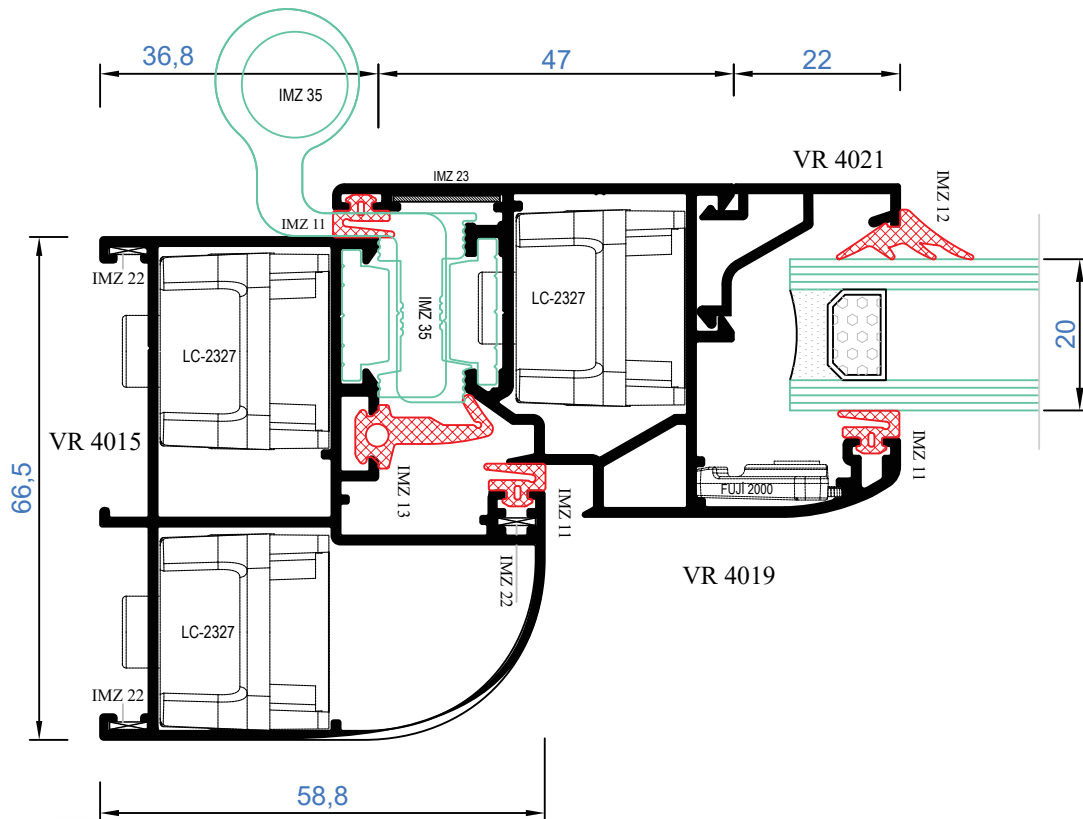
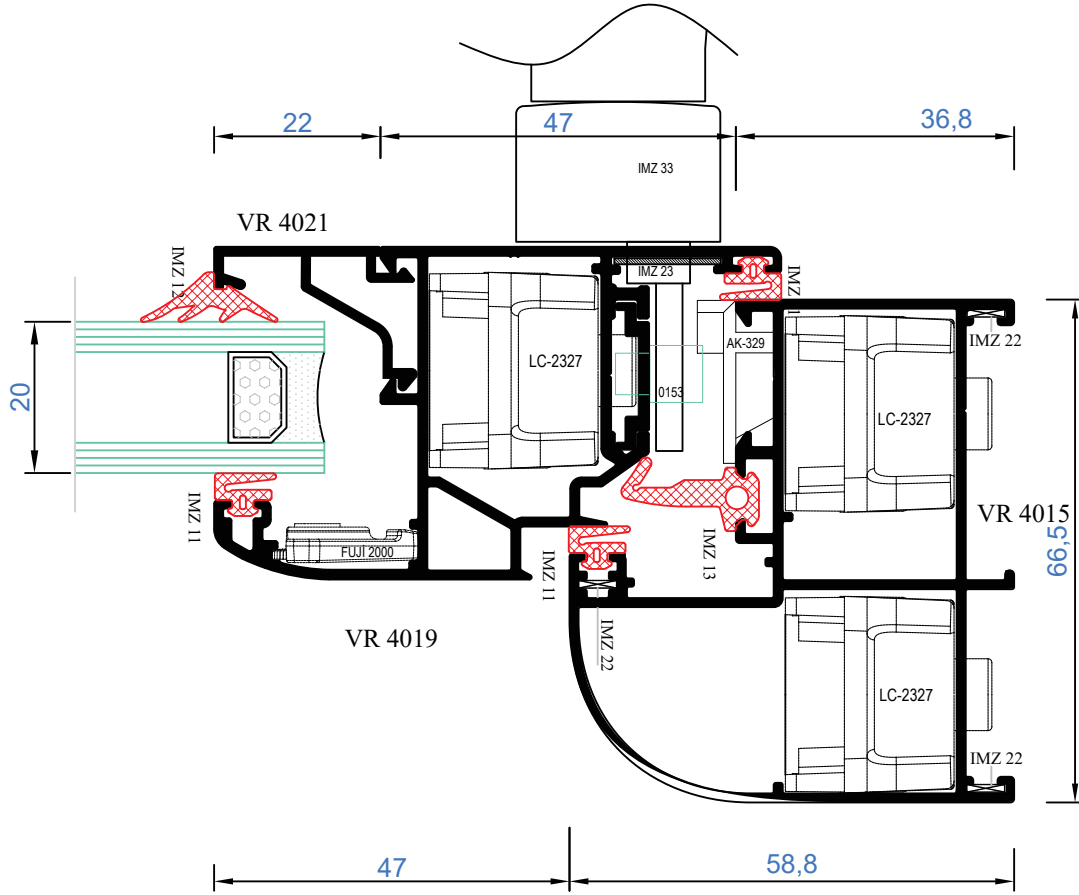

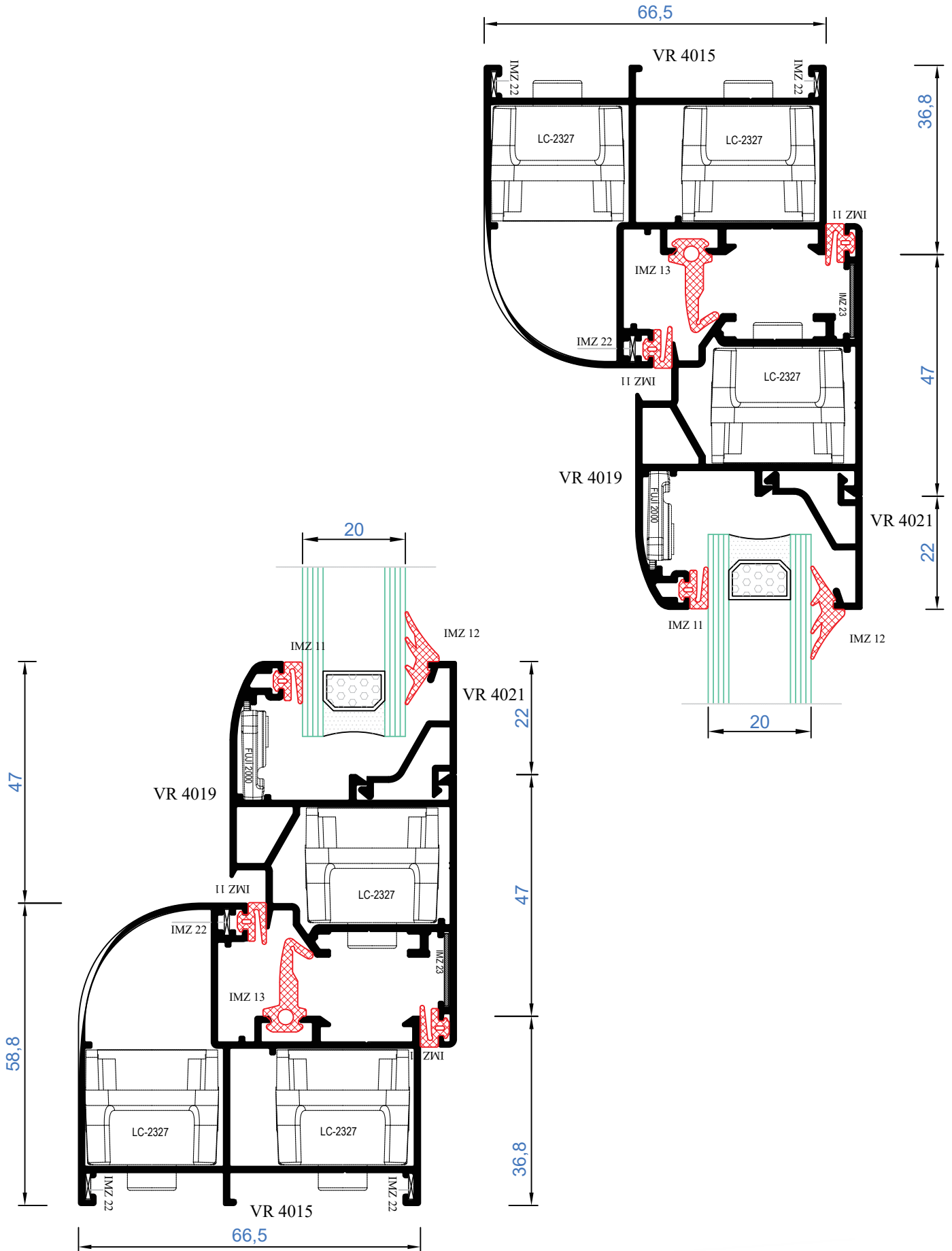
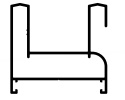

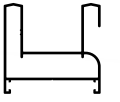

VR 28 SÜRME VE SİSTEM PROFİLLERİ
VR 28 SLIDING AND SYSTEM PROFILES

VR
VIALO ROKSA

MİMARİ SİSTEMLER

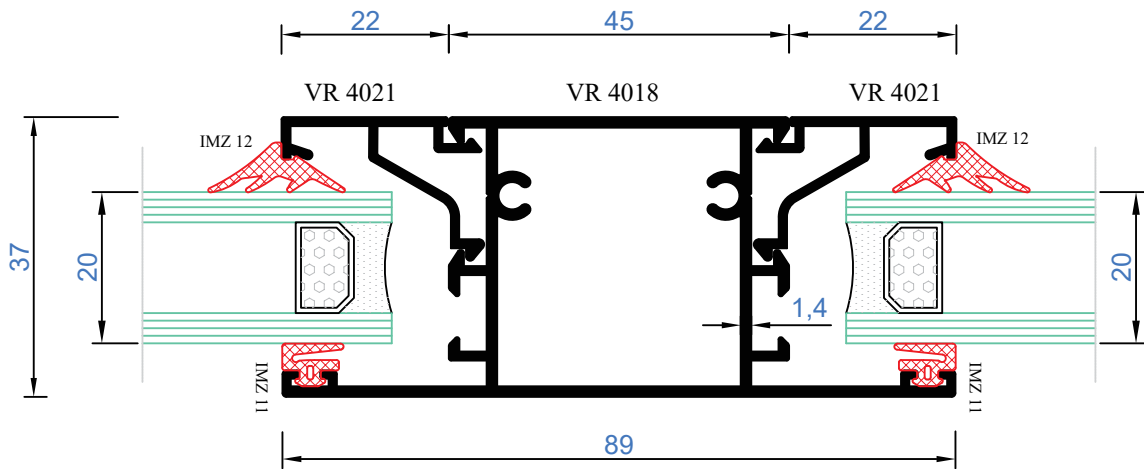
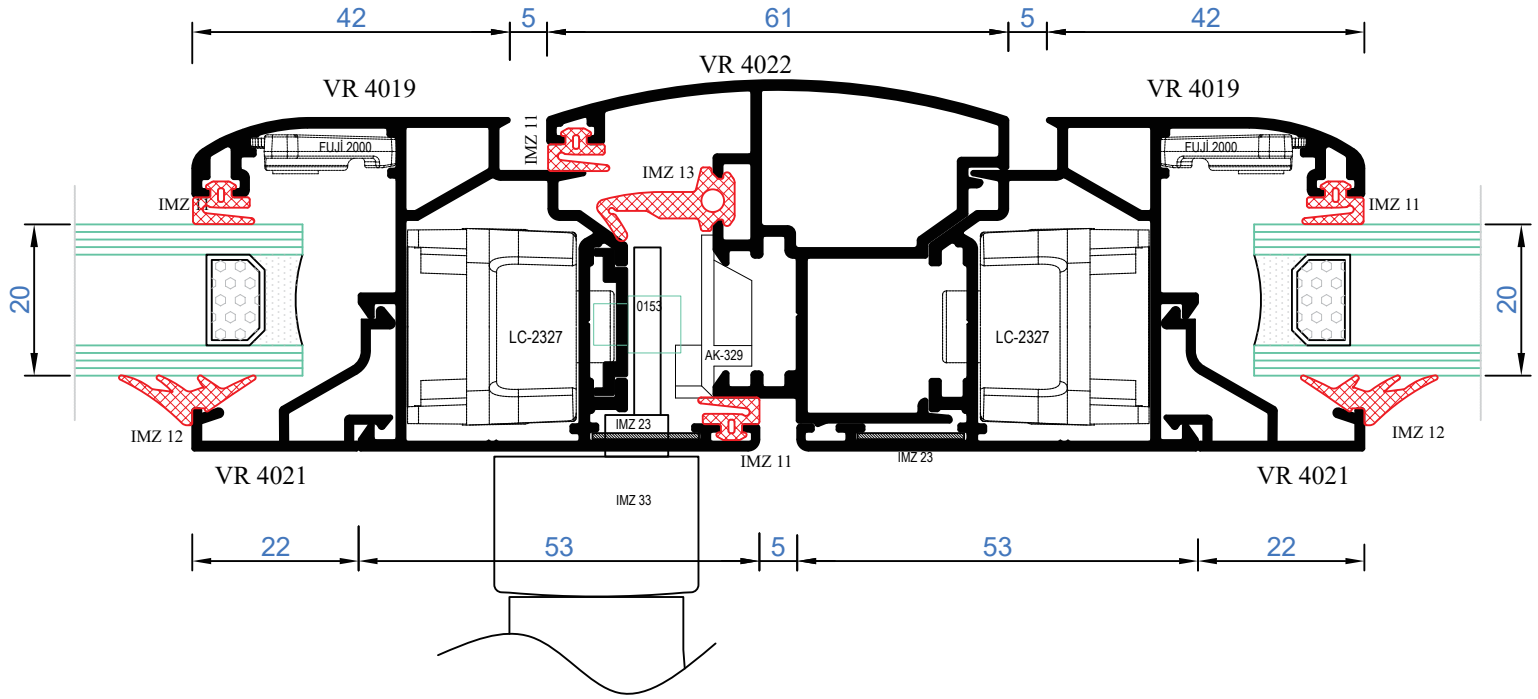

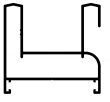

VR 28 SÜRME VE SİSTEM PROFİLLERİ

VR 28 SLIDING AND SYSTEM PROFILES

VR
VIALO ROKSA

MİMARİ SİSTEMLER

